

# 9LR 10Lp+R

73 - 93 kNm	8,0 - 9,7 m	3,29 - 3,48 m	3,8 - 5 m	1.950 - 2.020 kg	420°	20 kNm	215 - 255 bar	Minimum 80 l/min ~ 31 kW	Minimum 60 l/min ~ 47 kW	Minimum 150 l/min ~ 60 kW

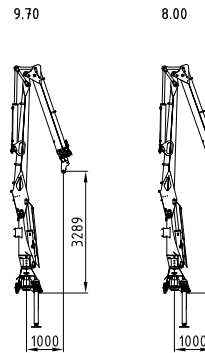

Kransockel schmal  
Crane base small

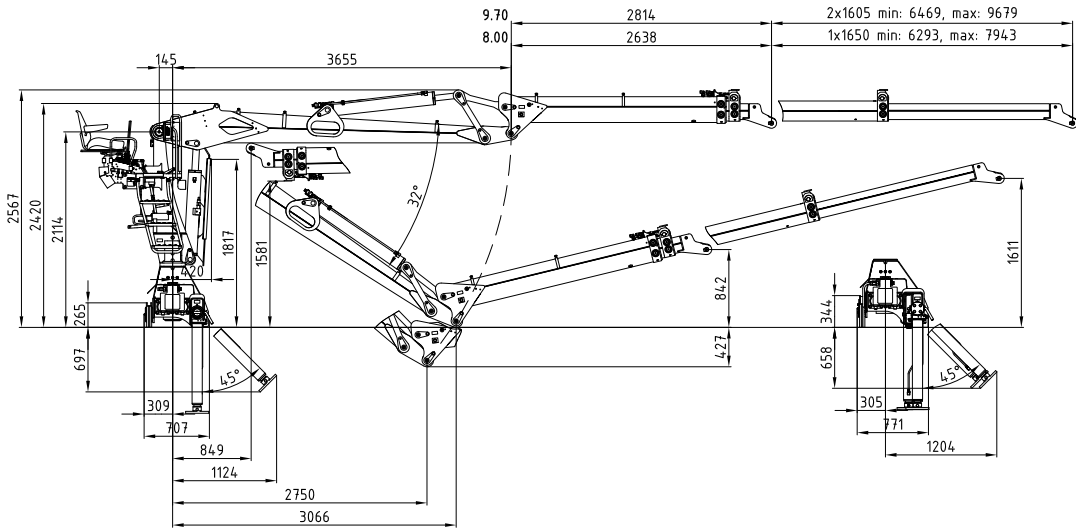
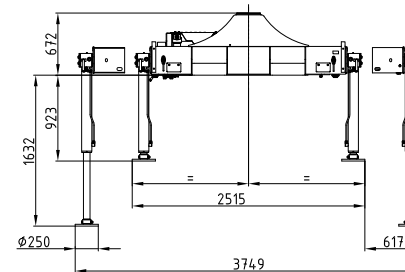

Kransockel breit  
Crane base wide

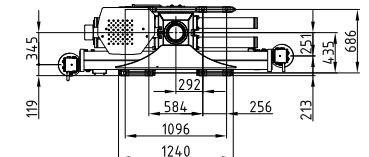
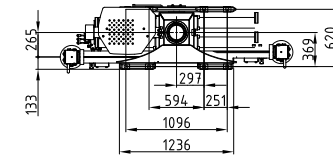
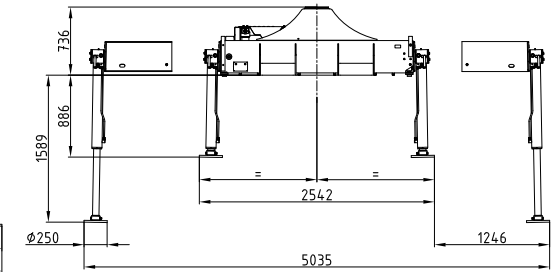

Rücksitz 01  
Back seat 01

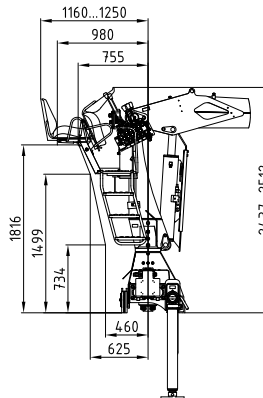

Rücksitz 04  
Back seat 04

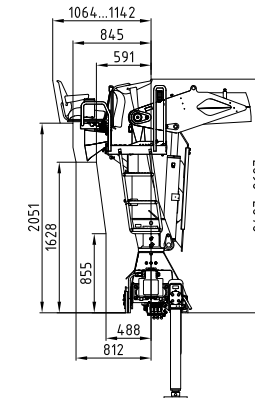

Seitensitz 04  
Side seat 04

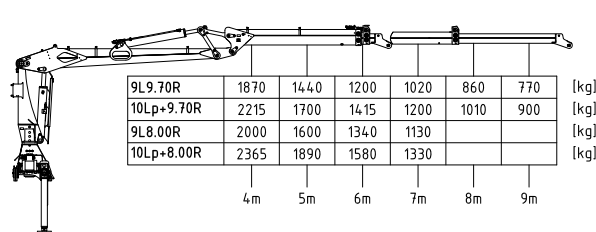
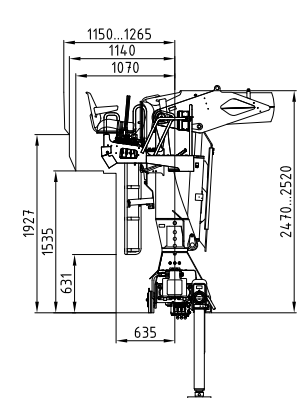

170° Hochklappung  
170° of lifting up

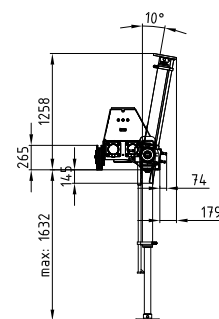

Hublasten netto ohne Lastaufnahmemittel / lifting capacities without equipment

Rev06 erstellt am / established on 18.07.2017 von / by SoS

Technische Änderungen vorbehalten / technical changes reserved